

DLT SERIES

DC Current Transducers

DLT Series DC Current Transducers combine a Hall effect sensor and a signal conditioner into a single package. The DLT Series DC Current Transducers are designed to produce an analog 4–20 mA signal proportional to the DC current in the primary conductor. These transducers are available in a solid-core or split-core case design. Lower current ranges make this sensor ideal for use in photovoltaic panel combiner boxes.

DC Current Transducer Applications

DC Current Monitoring

- PV Array combiner boxes.
- Wind generators.
- DC heating applications.
- UPS system monitoring.

Photovoltaic Arrays

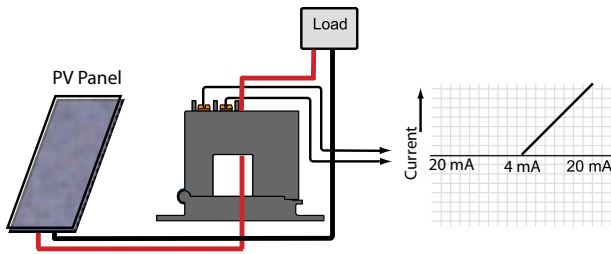

For additional Application Examples, go to www.nktechnologies.com/applications

Monitoring PV Arrays:

The current produced by a photovoltaic module or array can be easily monitored by using the DLT series current sensors over the conductor exiting the collectors. Using a simple two-wire connection powered by 24 VDC nominal in series with the sensor output, the sensor will produce a signal in real time that is directly proportional to the current being produced by the PV module.

If a single cell fails, or a module quits operating properly, the current output will drop, and the current sensor will reflect the change.

Safer and more stable than shunts, non-contact current sensors are a simple answer to measuring DC current at any point in the PV system.



DC Current Transducer Features

4–20 mA Loop-powered Output

- Industry standard connections, positive indication of correct field wiring.

Single Range

- No chance of field range selection errors.
- Eliminates zero and span pots.

Isolation

- Output is magnetically isolated from the primary circuit for safety.
- Eliminates insertion loss (voltage drop).

UL/cUL and CE Approved

- Accepted worldwide.

DC Current Transducer Output

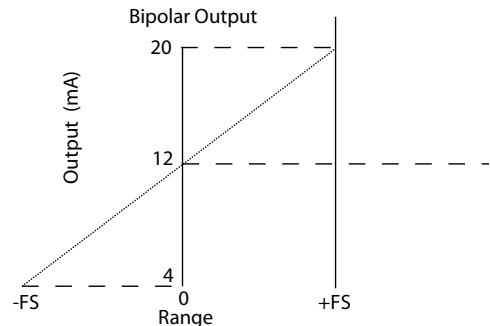
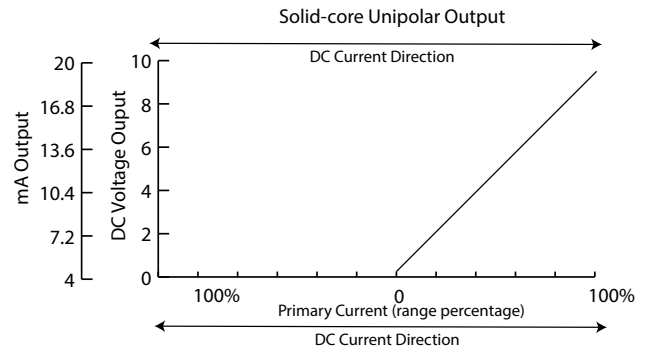

OEMs Test & Evaluation Units for OEMs
Free program expedites evaluation process. See page 3 for details.

DC Current Transducer Dimensions

FF Case

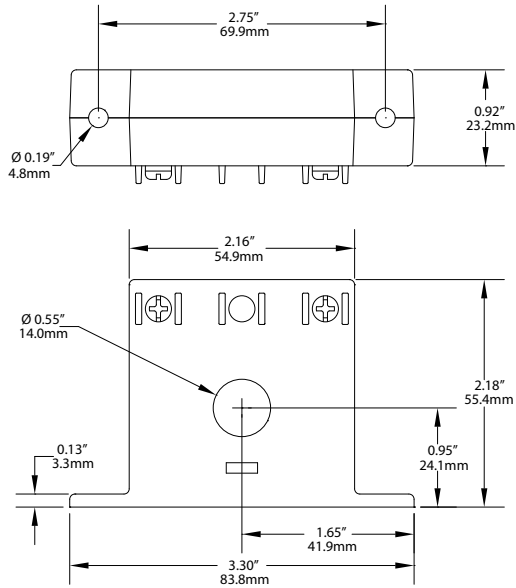

SP Case

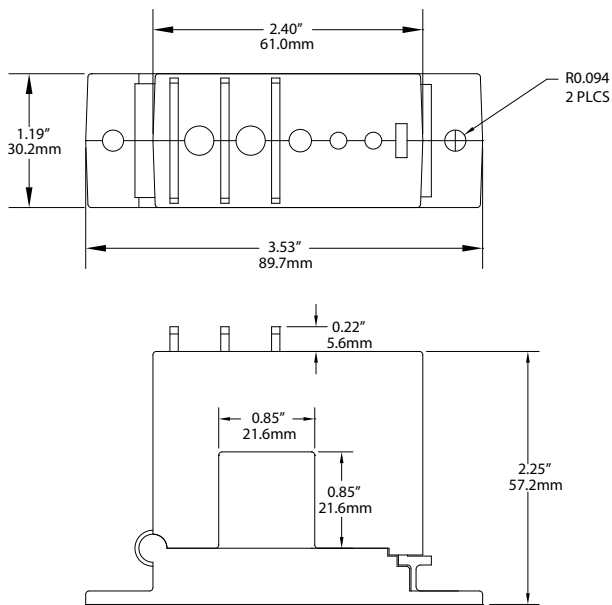

DC Current Transducer Connections

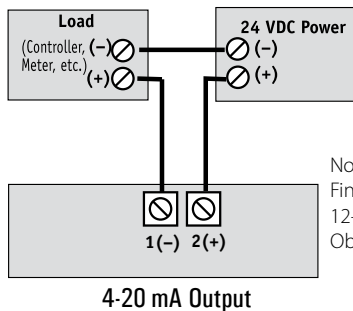

Notes:
Fingersafe captive screw terminals.
12–22 AWG solid or stranded.
Observe polarity.

DC Current Transducer Specifications



Power Supply	24 VDC (12–40 V)
Output Signal	4–20 mA, loop-powered
Output Limit	23 mA
Accuracy	1.0% FS
Response Time	100 ms (to 90% step change)
Range	0–20 to 0–400 DC, see ordering information
Frequency Range	DC
Isolation Voltage	UL listed to 1270 VAC, tested to 5 kV
Case	UL94 V-0 Flammability Rated
Environmental	-4 to 122°F (-20 to 50°C) 0–95% RH, non-condensing
Listings	UL/cUL, CE

DC Current Transducer Ordering Information*

Sample Model Number: DLTB-420-24L-BP-FF
DC current transducer, 50 A range, 4–20 mA output, 24 VDC loop-powered in a solid-core case. (DIN rail adapters are included)

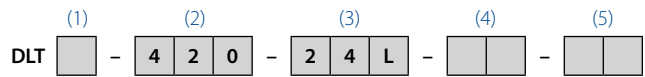

(1) Full Scale Range	
A	0–20 A
B	0–50 A
C	0–100 A
D	0–200 A
E	0–300 A
F	0–400 A
(2) Output Signal	
420	4–20 mA
(3) Power Supply	
24L	24 VDC loop-powered
(4) Output Polarity	
U	Unipolar
BP	Bipolar
(5) Case Style (black only)	
FF	Solid-core, front terminals (max. range 0–100 A)
SP	Split-core (min. range 0–50 A)

*Bulk packaging only.

DC Current Transducers

